

Ø64

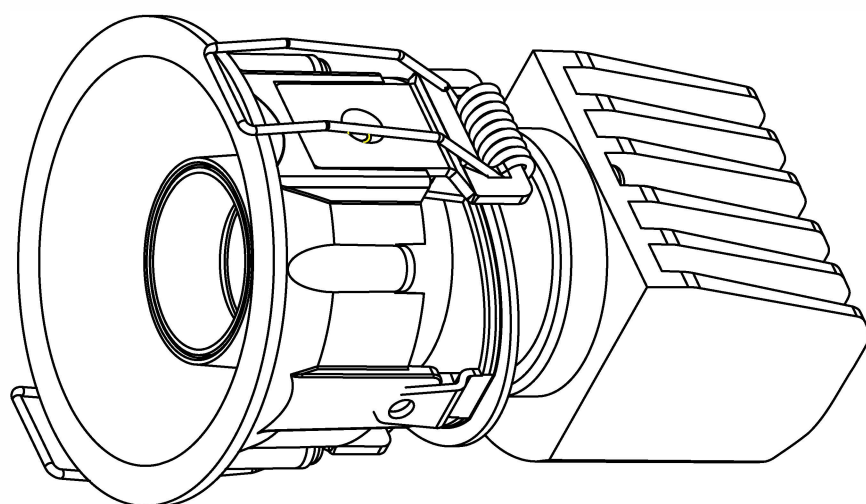

102